

Easy to Follow Instructions

5124197 Gaseous Zombie



Please read all instructions carefully before assembling.

Care & Storage Instructions: Store product in its original package. Keep away from heat & moisture. For indoor use only. Save instruction sheet for future reference.

This item, when assembled by the following instructions, should take 5-10 minutes to assemble. Please follow the step by step guide and enjoy your Gaseous Zombie.

Parts:

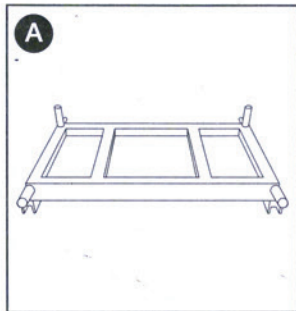

Base

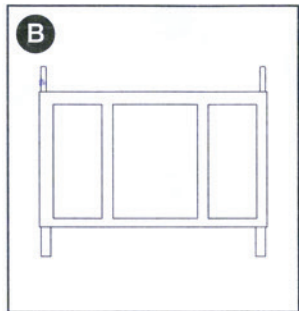

Lower Frame

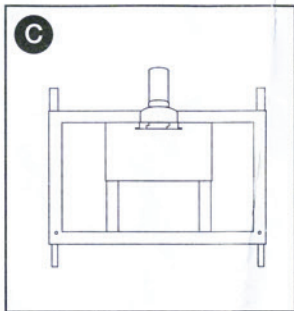

Top Frame

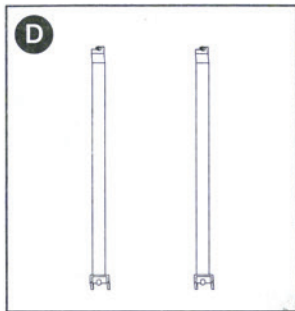

Support Beams x 2

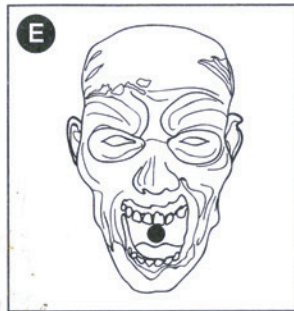

Head



Hands



Shirt

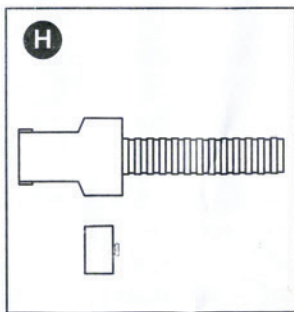

Hose with adapter

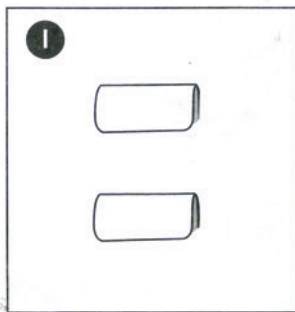

Shoulders x 2

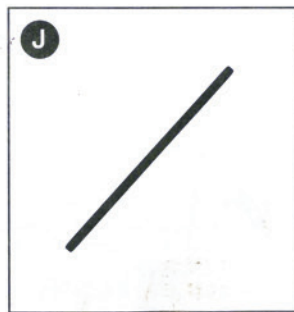

Center Pole

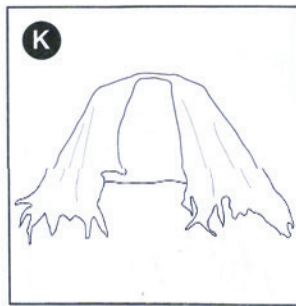

Cloak



AC Adapter Specification:
Input: 100V~240VAC 50/60Hz
Output: 5.9V 1.5A

Only use adapter with same technical specification.

ASSEMBLY INSTRUCTIONS: Unplug when not in use. It is not a toy and is not intended for Children. Please use it with adult supervision.

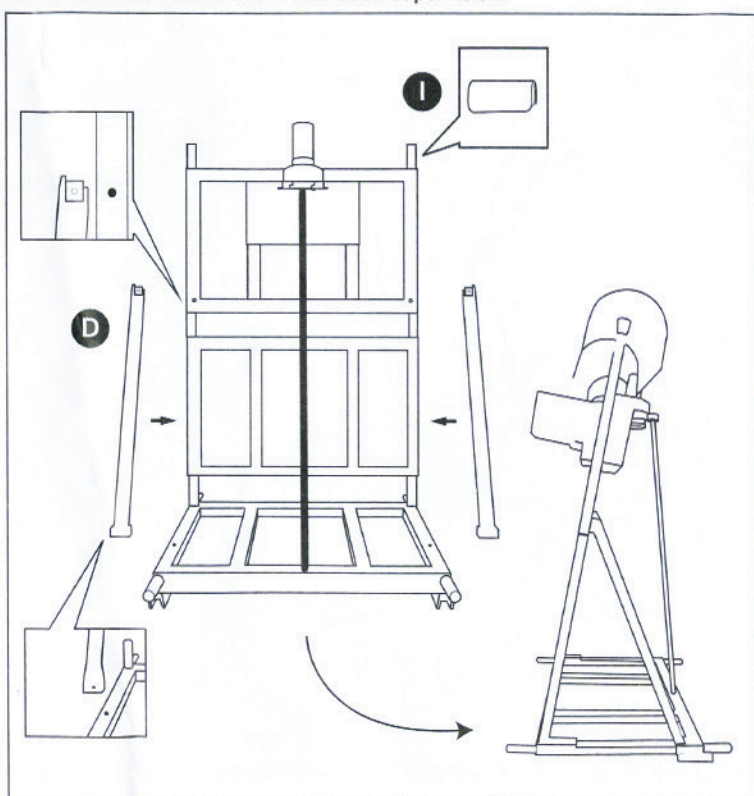
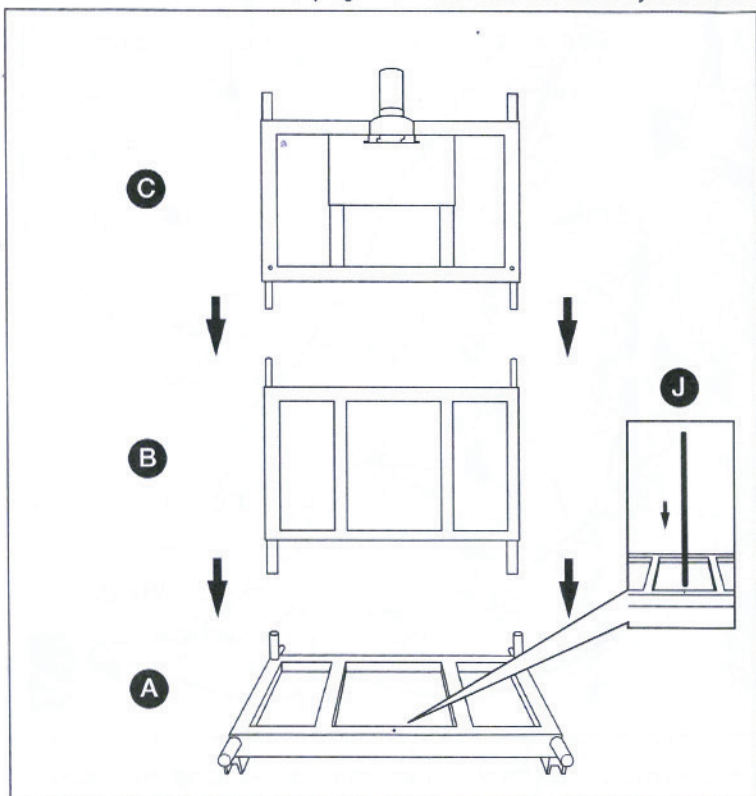

NOTE: The end of the base with the center slot goes towards the front.

Assemble the middle frame section & center pole to the base as shown. Then attach the top frame with motor to the middle frame.

Slide the two shoulder pieces on the left & right "shoulder slots" of the top frame. Then attach the support beams to the frame base and the top frame section into the pegs of the frame as shown.

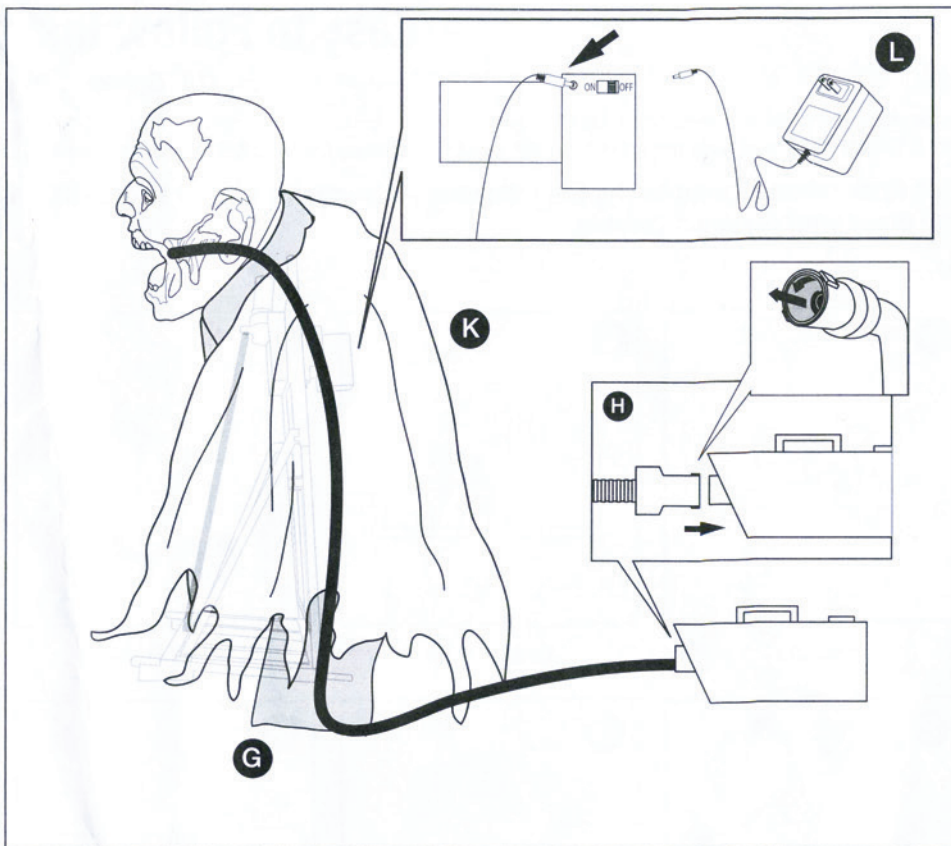
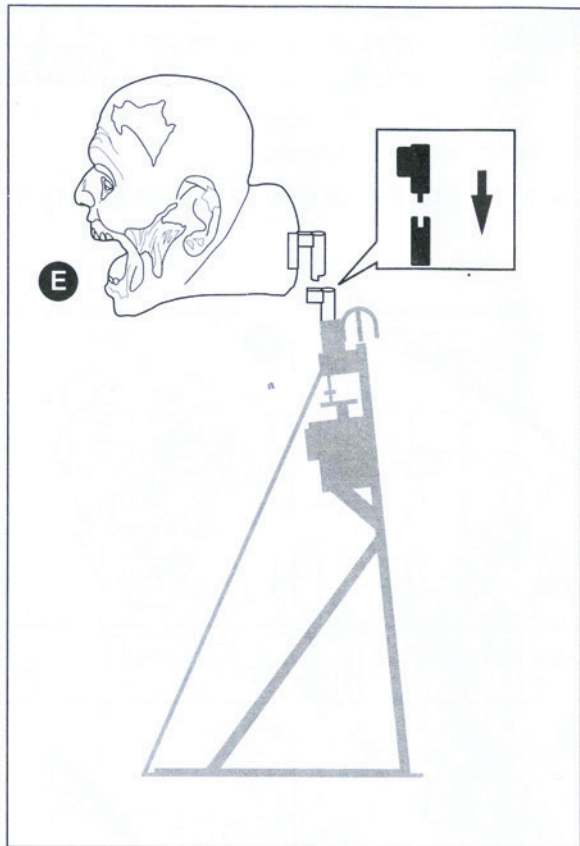

Carefully slide the "head support bracket" into the "neck slot" as shown. Carefully slide shirt over the frame. NOTE: The back of the costume opens and closes with hook & loop fastener tabs. Plug the AC adapter to the back as shown above.

For use with fog machines (not included), run the connector hose up the inside-back of the costume and over the top of the "head support bracket" and into the back of the head as shown. Guide the small end of the connector hose through the head so that the tip plugs into the mouth hole. Connect the other end to your fog machine nozzle.

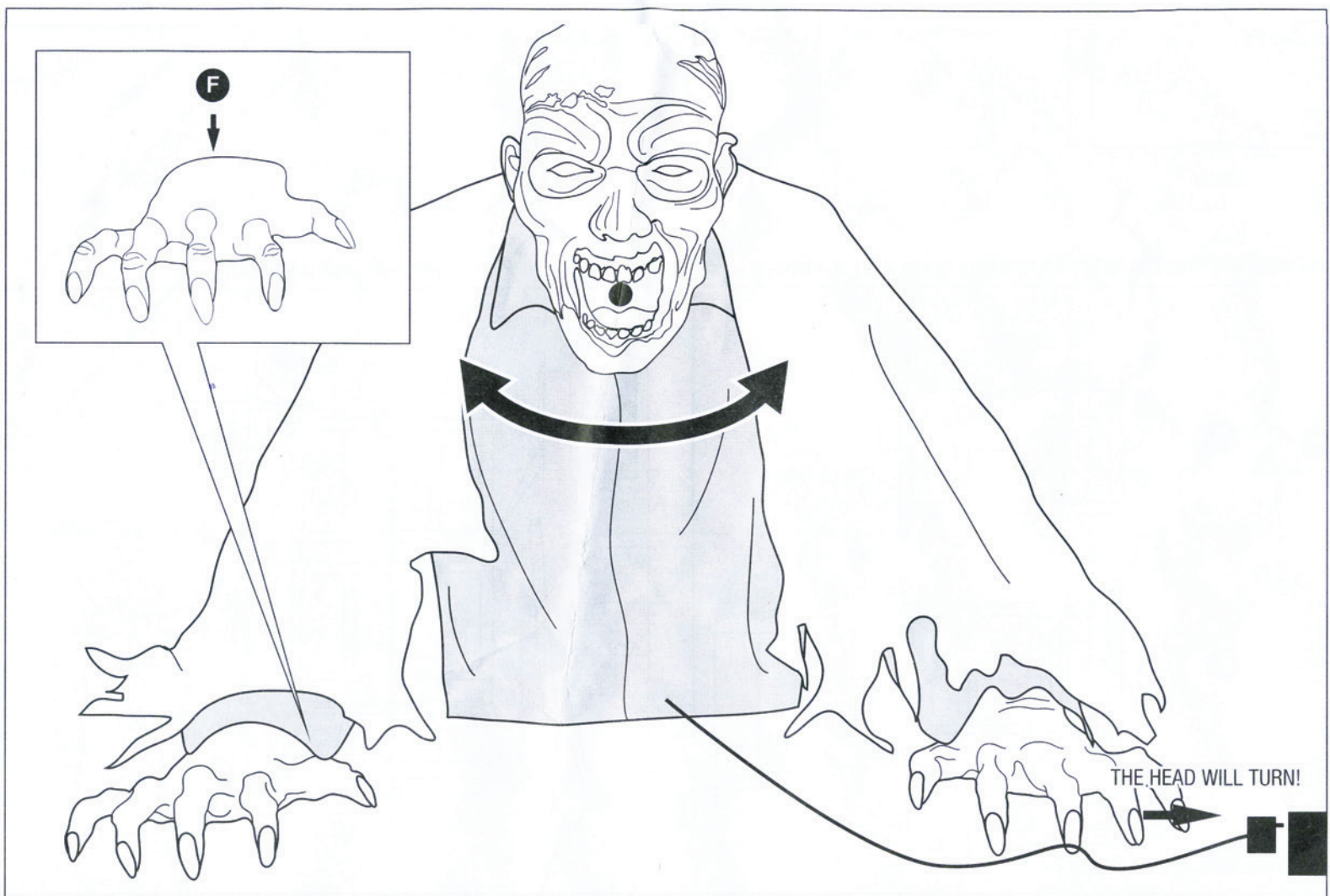

Attach the Hands to the sleeves with the hook & loop fasteners at the wrists. NOTE: For added realism, stuff the sleeves with balled-up newspaper (not included). Drape Cloak over the shoulders as shown.

Plug the adapter into a standard two-prong power outlet, and slide the "ON/OFF" switch located on the motor to "ON" to operate the head movement.

Recommend to use with 400W Fog Machine only.(not included)