

14194079 Pet Hamster Home Craft Kit

Instructions:

Assemble the box as shown.

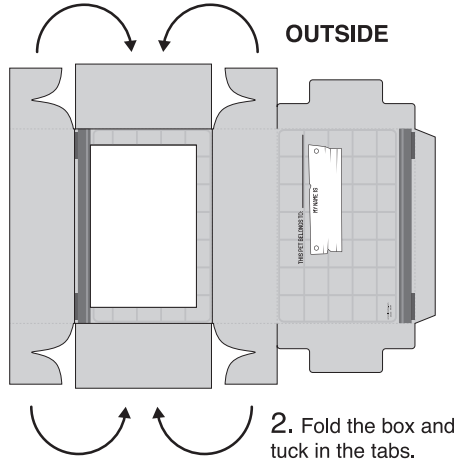
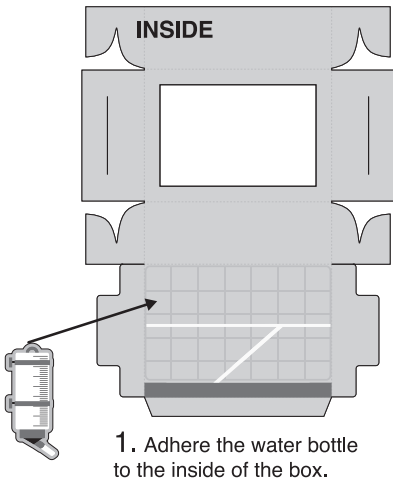

3. Tuck back tabs into side slots.

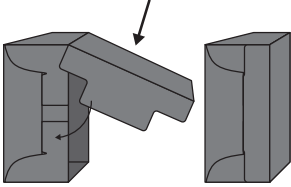

4. Adhere the slotted pieces to the inside bottom of the box.

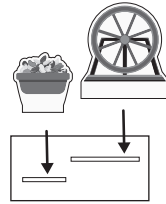

5. Fold handle in half and adhere the bottom of the handle to the top of the box.

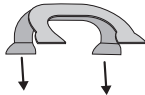

6. Adhere the tunnel to the back of the box

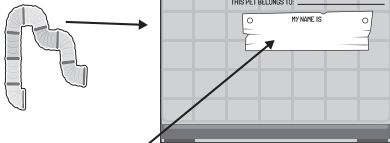

7. Write your hamster's name in the name tag.

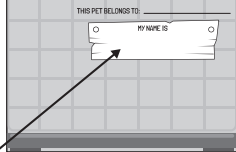

ASSEMBLED CRAFT

8. Your pet hamster is ready to play in its new home!

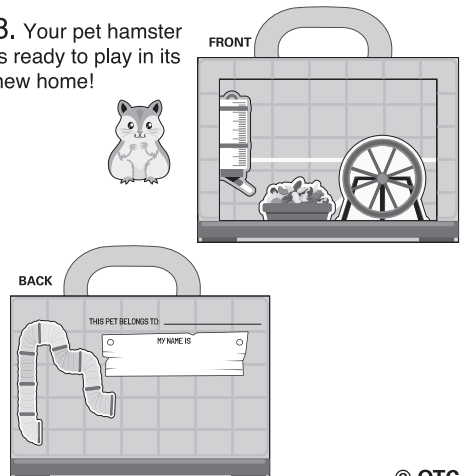

© OTC